

## Rugged Subracks Side panel

- Ruggedized subracks with lightweight
- Front bracket and side plate are designed in an integrated way, and the stiffener design is added, so the structure is strong, Obvious degree improvement (see the figure below)
- EMC electromagnetic compatibility structure design meets the requirements of EMC demand
- Meet the vibration and impact test standards IEC 61587-1, 50155, BN411002, NF 67012, NF F67002, electromagnetic compatibility VG95373, Part 5 Test Standards
- The intelligent assembly workstation is used for assembly, and the torque with high accuracy and quality can be, And angle control torque information and assembly process for later storage, trace back to



### Order information

Height h	Width W	Depth D	Order no
7U	42TE	200mm	03720042
7U	42TE	260mm	03726042
7U	63TE	200mm	03720063
7U	63TE	260mm	03726063
7U	84TE	200mm	03720084
7U	84TE	260mm	03726084

### Common Side panel

- Model Name: Side panel
- Example Name: Example 1
- Diagram type: Static displacement

Displacement 1

- proportion of deformation: 44.3403

URES (mm)

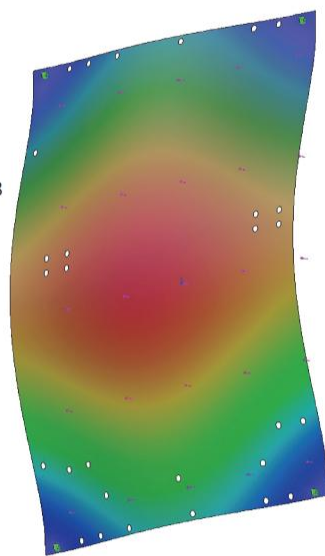
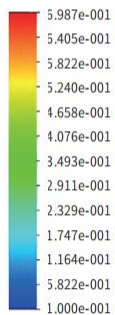

### Rugged Subracks Side panel

- Model Name: Side panel
- Example Name: Example 2
- Diagram type: Static displacement

Displacement 2

- proportion of deformation: 67.7489

URES (mm)

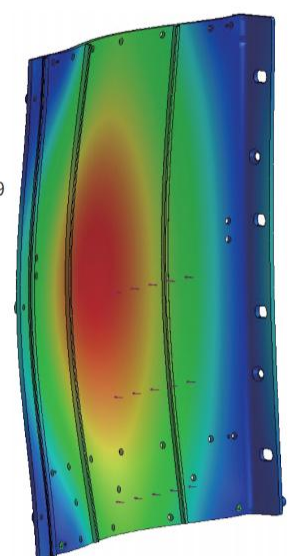
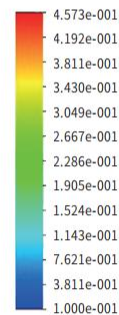

## Rugged Subracks Side panel

Section of left and right side plate profiles

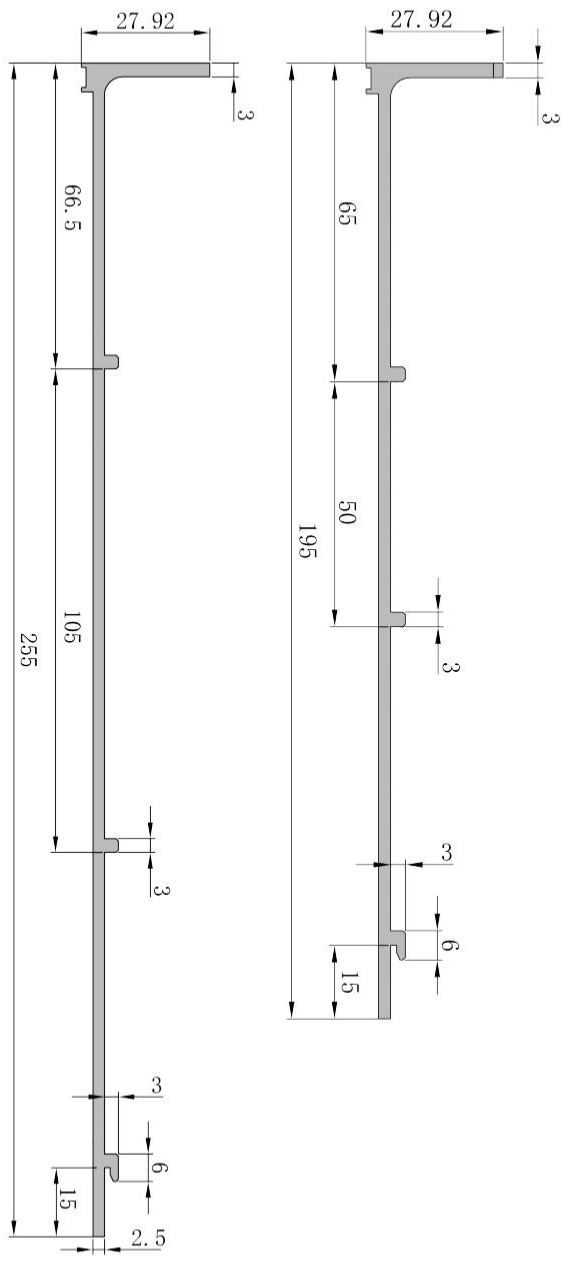

## Intelligent Assembly Workstation Features

- Material Picking Tips
- Standard parts gripping tray
- Electric torque wrenches, electric screwdrivers hanging and placing sensors
- Out of material alarm
- Installation sequence prompt light
- After all processes are assembled with video photo data analysis and qualified, the light will be prompted, and the finished product will be swept off the line and transported to the next workstation for the next process
- Product assembly process video tracking automatic feedback performance, automatic archiving to facilitate product source traceability, equipment program left with MES communication protocol port to facilitate enterprise scheduling and performance assessment

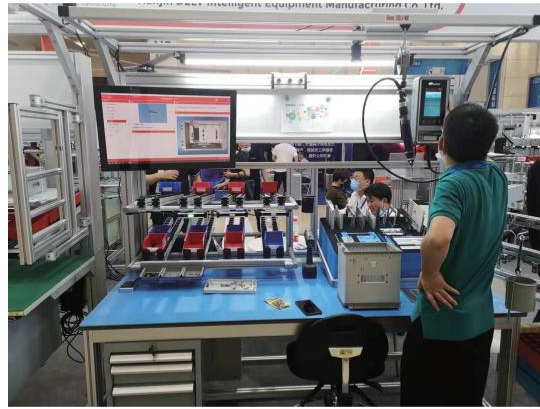

## Application of intelligent torsion system

- Storage of tightening torque information for accurate and high-quality torque and angle control for later traceability



EK&BEG PRO Series Subracks
EK+&EG+ PRO Series Subracks
BEK&BEG PRO Series Subracks
Handle specification and accessories
Guide rail specification and accessories
19" CUR Series Subracks
SNCF Series Subracks
Shielded plug-in units Series Subracks
VERO Series Subracks
Protective Series Subracks
CASE Series Subracks
Type A Series Subracks
Rugged Subracks Side panel
IN-S Series Subracks
Subracks Accessories
Panel component
Order no. and page Table



## Rugged Subracks Side panel

- Ruggedized subracks with lightweight
- Front bracket and side plate are designed in an integrated way, and the stiffener design is added, so the structure is strong, Obvious degree improvement (see the figure below)
- EMC electromagnetic compatibility structure design meets the requirements of EMC demand
- Meet the vibration and impact test standards IEC 61587-1, 50155, BN411002, NF67012, NF F67002, electromagnetic compatibility VG95373, Part 5 Test Standards
- Applicable to 160 mm and 220 mm board depth (depending on subracks depth)
- Support the installation of cooling fan (3U+1U)

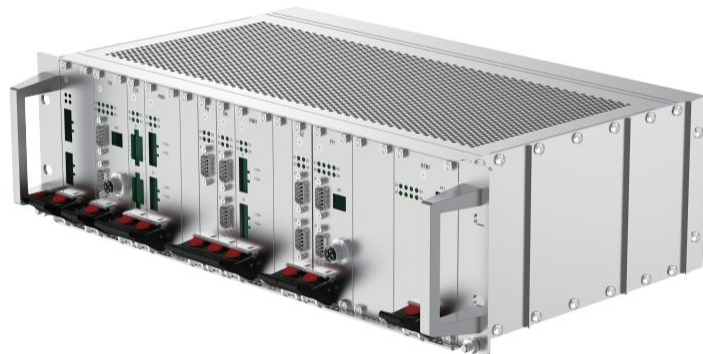

### Order information

Height h	Width W	Depth D	Order no
3U	42TE	200mm	03320042
3U	42TE	260mm	03326042
3U	63TE	200mm	03320063
3U	63TE	260mm	03326063
3U	84TE	200mm	03320084
3U	84TE	260mm	03326084
4U	42TE	200mm	03420042
4U	42TE	260mm	03426042
4U	63TE	200mm	03420063
4U	63TE	260mm	03426063
4U	84TE	200mm	03420084
4U	84TE	260mm	03426084



EK&EG PRO Series Subracks  
 EK+EG+PRO Series Subracks  
 BEK&BEG PRO Series Subracks  
 Handle specification and accessories  
 Guide rail specification and accessories  
 19" CUR Series Subracks  
 SNCF Series Subracks  
 Shielded plug-in units Series Subracks  
 VERO Series Subracks  
 Protective Series Subracks  
 CASE Series Subracks  
 Type-A Series Subracks  
 Rugged Subracks Side panel  
 IN-S Series Subracks  
 Subracks Accessories  
 Panel component  
 Order no. and page Table

# Rugged Series Subracks



## Rugged Subracks Side panel

- Ruggedized subracks with lightweight
- Front bracket and side plate are designed in an integrated way, and the stiffener design is added, so the structure is strong, Obvious degree improvement (see the figure below)
- EMC electromagnetic compatibility structure design meets the requirements of EMC demand
- Meet the vibration and impact test standards IEC 61587-1, 50155, BN411002, NF67012, NF F67002, electromagnetic compatibility VG95373, Part 5 Test Standards
- Applicable to 160 mm and 220 mm board depth (depending on subracks depth)



### Order information

Height h	Width W	Depth D	Order no
6U	42TE	200mm	03620042
6U	42TE	260mm	03626042
6U	63TE	200mm	03620063
6U	63TE	260mm	03626063
6U	84TE	200mm	03620084
6U	84TE	260mm	03626084

### Left and right side plate profiles

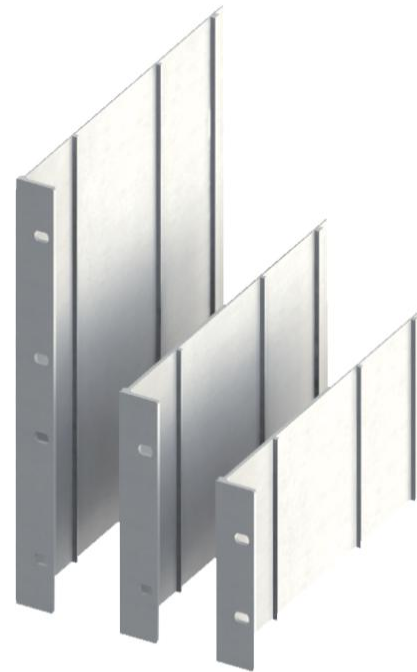

EK&EG PRO Series Subracks
EK&EG+ PRO Series Subracks
BEK&BEG PRO Series Subracks
Handle specification and accessories
Guide-rail specification and accessories
19" CUR Series Subracks
SNCF Series Subracks
Shielded plug-in units Series Subracks
VERO Series Subracks
Protective Series Subracks
CASE Series Subracks
Type A Series Subracks
Rugged Subracks Side panel
IN-S Series Subracks
Subracks Accessories
Panel component
Order no. and page Table